

CEAG Products
Explosion protected floodlights

CROUSE-HINDS
SERIES



PXLED - Power Floodlight Series for Hazardous Areas
Explosion-protected LED floodlight series for Zone 1, 2, 21 and 22



EATON

Powering Business Worldwide

Ex-Floodlight PXLED

(Ex-Zone 1, 2, 21 and 22)

Lighting under harsh conditions

The new modular LED floodlight series PXLED is suited for nearly every kind of lighting task in hazardous areas, including applications in On- and Off-shore, heavy industrial, chemical, petrochemical, oil and gas, pharmaceuticals, shipyards, dockyards, power generation, paper mills and wastewater treatment indoor and outdoor with potentially explosive areas under harsh conditions like vibrations, dust, moisture or corrosive atmospheres and extreme temperatures. The PXLED comes with a standard U-shaped mounting bracket for ceiling and wall mounting

Replacement of conventional light fittings up to 600 W

With a luminous flux from 5,000 lm up to 32,000 lm this floodlight series can be used to replace nearly every floodlight with conventional light sources with an equivalent power consumption from 70 W up to 600 W.

High efficient LED technology

High efficient power LED module with 110 Lumen/Watt enables up to 70 % energy-cost savings compared to conventional HID lamp.

Safety first

All PXLED multi-module floodlights from size 10L to 30L are equipped with a multichannel LED driver. This driver provides for each LED-module a separate power channel circuit. Even if one circuit fails, all other LED-modules are still working.

Modular design - just use the size you need

Thanks to the modular design of the PXLED series you can exactly choose the lumen output you need. There is no need to over/underdesign your lighting project. Six sizes are available from nominal 5,000 lm to more than 30,000 lm with a step-wide of 5000 lm.

Easy to install

A stainless steel swivel bracket with adjustable setting angle allows an easy alignment of the floodlight. A fixing screw



secures the alignment. The swivel bracket provides up to five Ø13 mm fixing holes for a safe assembly.

Different mounting accessories enable easy and safe mounting wherever required.

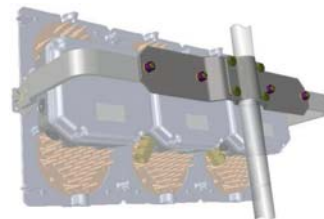

Together with two cable gland a large terminal compartment in Ex-e design allows cost saving through-wiring without additional terminal boxes.



The used Ex-e terminals can clamp up to 6 mm² wiring.

Internal and external PE-terminals allows nearly all cabling technique.



5 YEAR WARRANTY

Features

- High efficiency: up to 110 lm/W
- Operating temperature -50 °C up to +55 °C
- Suitable for Explosion Group IIC / IIIC environment
- Broad range of light output from 5,000 lm up to 32,000 lm
- Wide and narrow beam pattern (asymmetric beam on request)
- Long lifetime
- Ex-e compartment for driver & terminal for easy installation and maintenance

Features and Product details

PXLED for Ex-Zone 1, 2, 21 and 22

Designed for long lifetime

High ambient temperatures can drive the LED chip-temperature into a not permissible range. This would reduce the life-span of the LEDs tremendously. Eaton provides an enclosure design with large cooling pipes and a innovated heat reduction



design.

Tests done under the worst test conditions have shown that the LED-chip temperature is always below critical values. The designed life span for the LED (L80) is more than 60,000 h even at +55°C ambient temperature

The Eaton-LED driver is especially designed for the harsh conditions of hazardous environments. According to EN 61000-4-5 an electronic device must withstand a surge pulse of 1 kV between L- N, our LED driver is designed to withstand 4 kV between L- N and L, N - PE.



All electronic components with self-heating are over dimensioned to ensure a maximum maintenance-free period. The driver has an own Ex-certification "q" and is mounted within the Ex-e compartment.

In the very unlikely cause of an driver failure this unit can be changed separately from the floodlight.

Light distribution for various applications

Beside the various lumen output packages different light distributions can be realized with the PXLED-series.

A wide beam pattern as well as a narrow beam pattern is realized by the use of special designed lens caps for the LEDs. In addition, asymmetric light distributions are also available for special applications.

With a light transmission factor of more than 90 % we are able to offer a system efficiency of more than 110 lm/W.

The laminated glass version with external plastic foil, either in clear or frosted version, prevents any glass splitters from falling, allowing safe use in critical application such as food & beverage, chemical and pharmaceutical Industries

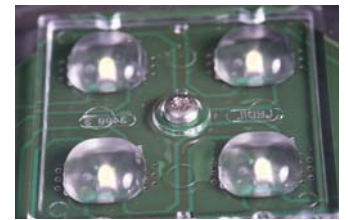

wide beam lens caps

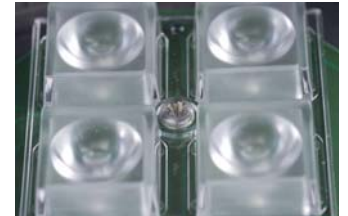

narrow beam lens caps

Type key for PXLED floodlight series

PXLED 10L W 7 57 GC T0 E01

Type of fitting: PXLED	Size of fitting ¹⁾ 5L = 5000 lm 10L=10000 lm 15L=15000 lm 20L=20000 lm 25L=25000 lm 30L=30000 lm	Light distribution: W = wide beam N = narrow beam C = asymmetric1 D = asymmetric2	CRI ²⁾ : 7 = CRI >70 X = other on request	CCT ³⁾ : 57 = 5700 K XX = other on request	Front glass: GC = clear FC = laminated, TX= others on request (on request) FF = laminated, frosted (on request)	Terminals: T0 = type 2410 - max. 6 mm ²	Cable entries/glands: E01= 2 x M25 metal gland type ADE 1F2 E05= 2 x M25 plastic threaded plug E11= 1 x M25 metal gland type ADE 1F2, 1 x M25 plastic threaded plug EXX= others on request
---------------------------	---	---	--	---	--	---	---

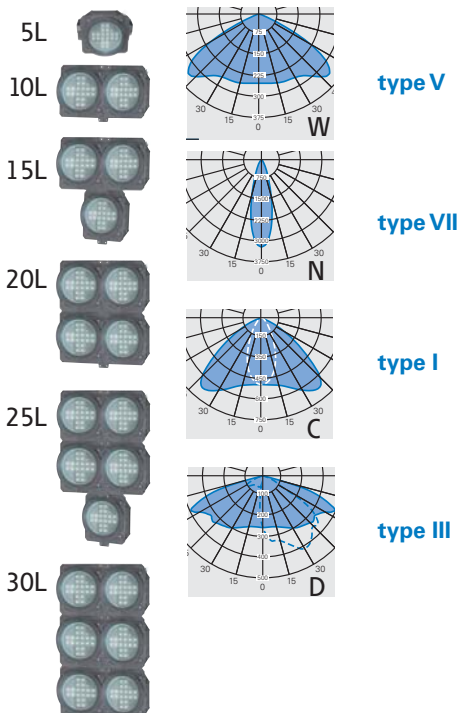

1) the lumen value is a design value and will not show the actual lumen output
2) CRI = Colour Rendering Index
3) CCT= Correlated Colour Temperature

Ordering details

PXLED, PXLED LV for Ex-Zone 1, 2, 21 and 22

Ordering details PXLED



Type	Lamp / illuminant	Light distribution *)	Description / Power	Cable glands	Order No..
	PXLED 5L N 757 GC E01	LED system 5.386 lm	narrow beam LED floodlight with swivel bracket 49 W	2 x M25 metal cable gland ADE 1F2 for Ø 10 - 17 mm	1 3042 110 001
	PXLED 5L N 757 GC E05			2 x M25 plastic threaded plug	1 3042 110 005
	PXLED 5L W 757 GC E01	LED system 5.207 lm	wide beam LED floodlight with swivel bracket 49 W	2 x M25 metal cable gland ADE 1F2 for Ø 10 - 17 mm	1 3042 111 001
	PXLED 5L W 757 GC E05			2 x M25 plastic threaded plug	1 3042 111 005
	PXLED 10L N 757 GC E01	2 LED systems 10.772 lm	narrow beam LED floodlight with swivel bracket 98 W	2 x M25 metal cable gland ADE 1F2 for Ø 10 - 17 mm	1 3042 210 001
	PXLED 10L N 757 GC E05			2 x M25 plastic threaded plug	1 3042 210 005
	PXLED 10L W 757 GC E01	2 LED systems 10.414 lm	wide beam LED floodlight with swivel bracket 98 W	2 x M25 metal cable gland ADE 1F2 for Ø 10 - 17 mm	1 3042 211 001
	PXLED 10L W 757 GC E05			2 x M25 plastic threaded plug	1 3042 211 005
	PXLED 15L N 757 GC E01	3 LED systems 16.158 lm	narrow beam LED floodlight with swivel bracket 147 W	2 x M25 metal cable gland ADE 1F2 for Ø 10 - 17 mm	1 3042 310 001
	PXLED 15L N 757 GC E05			2 x M25 plastic threaded plug	1 3042 310 005
	PXLED 15L W 757 GC E01	3 LED systems 15.621 lm	wide beam LED floodlight with swivel bracket 147 W	2 x M25 metal cable gland ADE 1F2 for Ø 10 - 17 mm	1 3042 311 001
	PXLED 15L W 757 GC E05			2 x M25 plastic threaded plug	1 3042 311 005
	PXLED 20L N 757 GC E01	4 LED systems 21.544 lm	narrow beam LED floodlight with swivel bracket 196 W	2 x M25 metal cable gland ADE 1F2 for Ø 10 - 17 mm	1 3042 410 001
	PXLED 20L N 757 GC E05			2 x M25 plastic threaded plug	1 3042 410 005
	PXLED 20L W 757 GC E01	4 LED systems 20.828 lm	wide beam LED floodlight with swivel bracket 196 W	2 x M25 metal cable gland ADE 1F2 for Ø 10 - 17 mm	1 3042 411 001
	PXLED 20L W 757 GC E05			2 x M25 plastic threaded plug	1 3042 411 005
	PXLED 25L N 757 GC E01	5 LED systems 26.930 lm	narrow beam LED floodlight with swivel bracket 245 W	2 x M25 metal cable gland ADE 1F2 for Ø 10 - 17 mm	1 3042 510 001
	PXLED 25L N 757 GC E05			2 x M25 plastic threaded plug	1 3042 510 005
	PXLED 25L W 757 GC E01	5 LED systems 26.035 lm	wide beam LED floodlight with swivel bracket 245 W	2 x M25 metal cable gland ADE 1F2 for Ø 10 - 17 mm	1 3042 511 001
	PXLED 25L W 757 GC E05			2 x M25 plastic threaded plug	1 3042 511 005
	PXLED 30L N 757 GC E01	6 LED systems 32316 lm	narrow beam LED floodlight with swivel bracket 294 W	2 x M25 metal cable gland ADE 1F2 for Ø 10 - 17 mm	1 3042 610 001
	PXLED 30L N 757 GC E05			2 x M25 plastic threaded plug	1 3042 610 005
	PXLED 30L W 757 GC E01	6 LED systems 31242 lm	wide beam LED floodlight with swivel bracket 294 W	2 x M25 metal cable gland ADE 1F2 for Ø 10 - 17 mm	1 3042 611 001
	PXLED 30L W 757 GC E05			2 x M25 plastic threaded plug	1 3042 611 005

*) Asymmetric light distribution on request

Ordering details PXLED LV (Low Voltage)

Type	Lamp / illuminant	Light distribution *)	Description / Power	Cable glands	Order No..
	PXLED 5L W 757 GC TO E01 LV	LED system 5.000 lm	wide beam LED floodlight with swivel bracket 49 W low voltage	2 x M25 metal cable gland ADE 1F2 for Ø 10 - 17 mm	1 3046 111 001
	PXLED 5L W 757 GC TO E05 LV	LED system 5.000 lm	wide beam LED floodlight with swivel bracket 49 W low voltage	2 x M25 plastic screw plug	1 3046 111 005
	PXLED 5L W 757 GC TO E15 LV	LED system 5.000 lm	wide beam LED floodlight with swivel bracket 49 W low voltage	1 x M25 plastic trumpet shaped cable gland, 1 x plastic blanking plug	1 3046 111 015
	PXLED 5L N 757 GC TO E01 LV	LED system 5.000 lm	narrow beam LED floodlight with swivel bracket 49 W low voltage	2 x M25 metal cable gland ADE 1F2 for Ø 10 - 17 mm	1 3046 110 001
	PXLED 5L N 757 GC TO E05 LV	LED system 5.000 lm	narrow beam LED floodlight with swivel bracket 49 W low voltage	2 x M25 plastic screw plug	1 3046 110 005

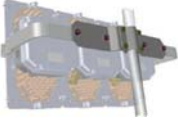
Ordering details Accessories

Type	Description	PXLED	Pole diameter (d)	Order No.		
	MH03	5L-20L	1 1/2"	47-51mm	2 3042 000 003	
	MH04	25L-30L	1 1/2"	47-51mm	2 3042 000 004	
	MH05	5L-20L	2"	56-60mm	2 3042 000 005	
	MH06	25L-30L	2"	56-60mm	2 3042 000 006	
	MH07	5L-20L	2 1/2"	70mm	2 3042 000 007	
	MH08	25L-30L	2 1/2"	70mm	2 3042 000 008	
		WH01	5L-20L			2 3042 000 009
		WH02	25L-30L			2 3042 000 010

Dimension drawing PXLED mounting accessories

Pole adaptor short MH03/05/07

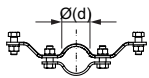

Pole adaptor short MH03/05/07

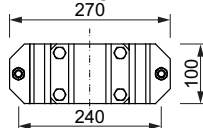

Pole adaptor long MH04/06/07

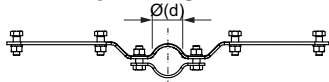

Pole adaptor long MH04/06/07

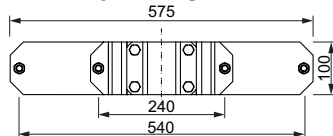

Angle adaptor short WH 01

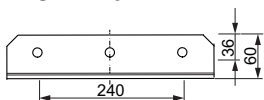

Angle adaptor short WH 01

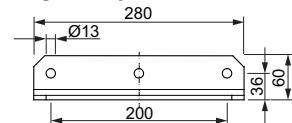

Angle adaptor short WH 01

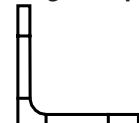

Angle adaptor long WH 02

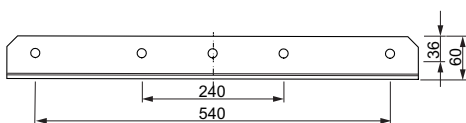

Angle adaptor long WH 02

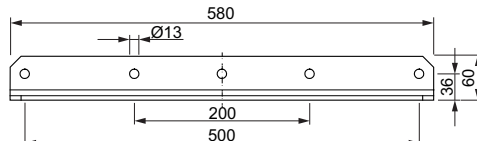

Angle adaptor long WH 02

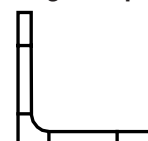

PXLED 5L

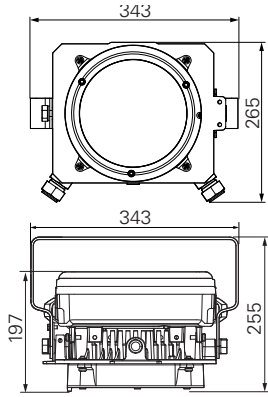

PXLED 15L

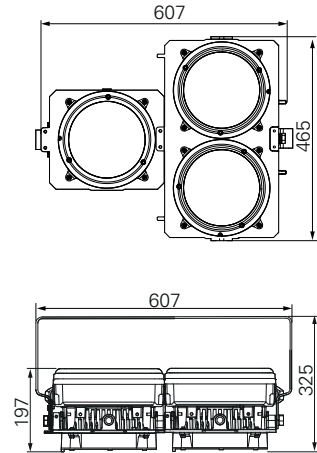

PXLED 25L

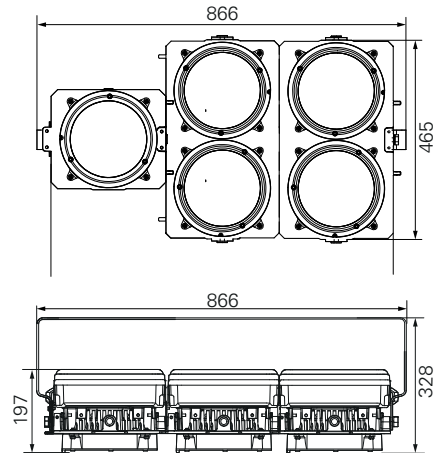

PXLED 10L

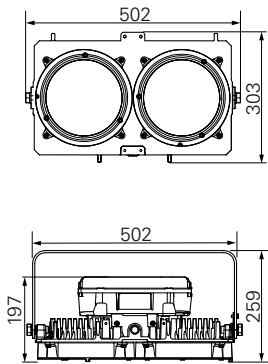

PXLED 20L

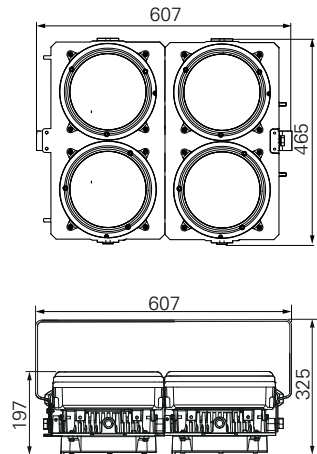

PXLED 30L

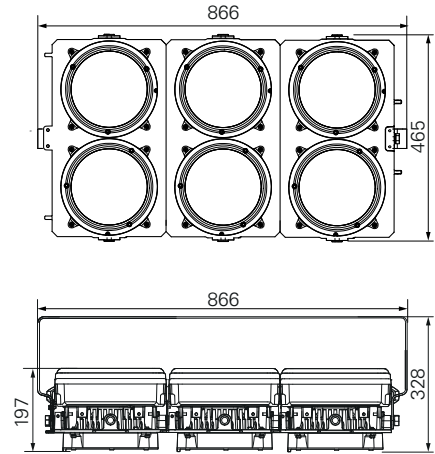

Dimensions in mm

Swivel bracket

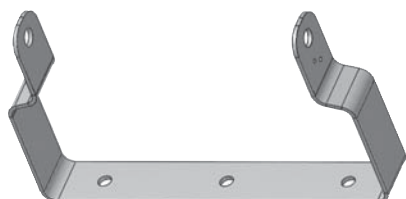
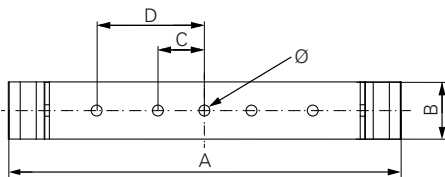

Swivel bracket for PXLED - Dimensions

Dimensions in mm	A	B	C	D	Ø
PXLED 05	343	50	120	-	13
PXLED 10	476	50	120	-	13
PXLED 15	606	50	120	-	13
PXLED 20	606	50	120	-	13
PXLED 25	858	50	120	270	13
PXLED 30	858	50	120	270	13

Technical data

	PXLED 5L	PXLED 10L	PXLED 15L	PXLED 20L	PXLED 25L	PXLED 30L	PXLED 5L LV
Type Examination Certificate	BVS 17 ATEX E 013 X						
IECEX Certificate of conformity	IECEX BVS 17.0004 X						
Marking accd. 2014/34/EU	II 2 G Ex db eb op is q IIC T4 Gb/ II 2 D Ex tb op is IIIC T100°C Db						
Marking accd. to IECEx	Ex db eb op is q IIC T4 Gb/ Ex tb op is IIIC T100°C Db						
Salt water resistance test acc. to EN 60068-2-52	Level IV						
Vibration test acc. to EN 60068-2-6	4,26 G						
Certification accd. to TR CU 012/2011 EAC ¹⁾	RU C-DE.AA87.B.00780 (-55 °C certified)						
IK-class according to IEC/EN 62262	IK 10 \pm 20 J						
Permissible ambient temperature	-50 °C up to +55 °C						
LED lifetime	L90 / L80 >100,000 h @ 25 °C / 60,000 h @ +55 °C						
Driver lifetime	C10 >100,000 h @ 25 °C / 60,000 h @ +55 °C						
Rated voltage	110 - 277 V AC / 127 - 270 V DC						24 - 48 V AC/DC
Frequency	0/50 - 60 Hz						
Rated current	0.24 A ²⁾	0.48 A ²⁾	0.72 A ²⁾	0.96 A ²⁾	1.20 A ²⁾	1.44 A ²⁾	1.1 A ³⁾
Inrush current	20 A/50 μ s	20 A/50 μ s	20 A/100 μ s	20 A/100 μ s	20 A/150 μ s	20 A/150 μ s	4 A/10 ms ⁴⁾
THD	<10 %	<10 %	<10 %	<10 %	<10 %	<10 %	0 ⁵⁾
Power factor cos ϕ ¹⁾	\geq 0.93	\geq 0.95	\geq 0.95	\geq 0.95	\geq 0.95	\geq 0.95	1 ⁶⁾
Circuit	Electronic driver						
Protection class	I						
Light distribution	Wide beam and narrow beam (asymmetric beam on request)						
Light colour / CRI	5700 K / R _a >70 (other colours on request)						
Enclosure colour	Dark grey						
Connecting terminals	6 poles standard (L, L1, L2, L3, N, PE / up to 6 mm ² / others on request)						
Enclosure material	Anodized copper-free Aluminium						
Weight	9,9 kg	14,4 kg	24,3 kg	28,7 kg	38,5 kg	41,1 kg	9,9 kg
Cable glands / gland plates / enclosure drilling	2 x M25 metal thread nickel plated (E01) or 2 x M25 threaded plug (E05) (others on request)						
Degree of protection accd. to EN 60529	IP66/67						
Protective cover / protective bowl	Toughened glass, clear						
Swivel bracket	AiSi 316L stainless steel						

¹⁾ Please ask our sales service for the special Order No.

²⁾ Typical value at 230 VAC

⁴⁾ Value at 24 VDC = 4 A/10 ms; 48 VDC = 8 A/10ms; 24 VAC = 8 A/5 ms; 48 VAC = 20 A/ 5 ms

³⁾ Value at 48 VDC = 1.1 A / 24 VDC = 2.3 A / 48 VAC = 1.85 A / 24 VAC = 3.5 A

⁵⁾ Value at 24 VDC = 0; 48 VDC = 0; 24 VAC = 120 % ; 48 VAC = 175 %

⁶⁾ Value at 24 VDC = 1; 48 VDC = 1; 24 VAC = >0.6 ; 48 VAC = >0.48

Polar curve

Polar curve PXLED 5L - 30L, narrow beam

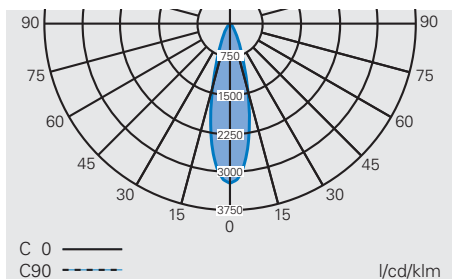

Polar curve PXLED 5L (LV) - 30L, wide beam

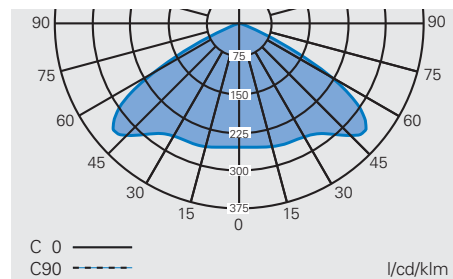

Polar curve PXLED 5L - 30L, asymmetric 1

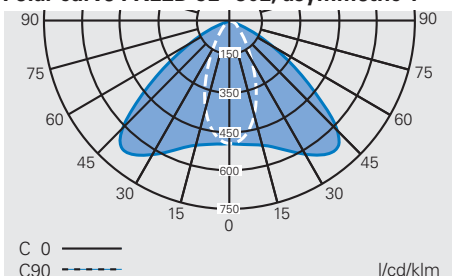

Polar curve PXLED 5L - 30L, asymmetric 2

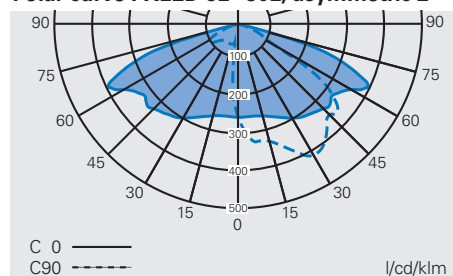



Eaton's Crouse-Hinds Business The safety you rely on.

See the complete offering of Hazardous and Industrial Products at www.crouse-hinds.de.

U.S. (Global Headquarters): Eaton's Crouse-Hinds Business

1201 Wolf Street
Syracuse, NY 13208

(866) 764-5454
FAX: (315) 477-5179
FAX Orders Only:
(866) 653-0640

CrouseCustomerCTR@Eaton.com

For more information:

If further assistance is required, please contact an authorized Eaton Distributor, Sales Office, or Customer Service Department.

Authorised Distributor:



46, Jalan SS 22/21, Damansara Jaya,
47400 Petaling Jaya,
Selangor Darul Ehsan, Malaysia.
Email: ampmech@ampmech.com
Website: www.ampmech.com

Eaton's Crouse-Hinds Business

Neuer Weg – Nord 49
D-69412 Eberbach

Phone +49 (0) 6271/806-500
Fax +49 (0) 6271/806-476
E-mail info-ex@eaton.com
Internet www.crouse-hinds.de



Eaton
1000 Eaton Boulevard
Cleveland, OH 44122
United States
Eaton.com

© 2019 Eaton Corporation
All Rights Reserved
Printed in Germany
Publication No. BR 300 8000 2288
July 2019

Changes to the products, to the information contained in this document, and to prices are reserved; so are errors and omissions. Only order confirmations and technical documentation by Eaton is binding. Photos and pictures also do not warrant a specific layout or functionality. Their use in whatever form is subject to prior approval by Eaton. The same applies to Trademarks (especially Eaton, Moeller, and Cutler-Hammer). The Terms and Conditions of Eaton apply, as referenced on Eaton Internet pages and Eaton order confirmations.

Eaton's Crouse-Hinds Business
1201 Wolf Street
Syracuse, NY 13208
(866) 764-5454
CrouseCustomerCTR@Eaton.com

Eaton is a registered trademark.

All other trademarks are property of their respective owners.