

Condulet EAB conduit outlet boxes with covers

Cl. I, Div. 1 & 2, Groups A, B, C, D
 Cl. II, Div. 1, Groups E, F, G
 Cl. II, Div. 2, Groups F, G
 Cl. III
 NEMA 3, 4, 7ABCD, 9EFG

Explosionproof
 Dust-ignitionproof
 Raintight
 Wet Locations

3F

Applications:

EAB conduit outlet boxes are installed in conduit systems within hazardous areas to:

- Provide protection against exterior explosion where acetylene, hydrogen and other hazardous gases are present
- Protect conductors in threaded rigid conduit
- Act as pull and splice boxes
- Interconnect lengths of conduit
- Change conduit direction
- Provide access to conductors for maintenance and future system changes

Features:

EAB conduit outlet boxes have:

- Five different hub configurations
- Taper threaded hubs to provide ground continuity
- Smooth integral hub bushing to protect conductor insulation when pulling
- Threaded cover openings
- Surface covers furnished with boxes
- Neoprene o-ring gasket and green ground screw are both standard
- Four standard mounting pads, except for EABY
- Cover threads are 16 pitch
- Internal green ground screw #10

Certifications and compliances:

NEC/CEC:

- Class I, Divisions 1 & 2, Groups A, B, C, D
- Class II, Division 1, Groups E, F, G
- Class II, Division 2, Groups F, G
- Class III

UL standard:

- UL1203

CSA standard:

- C22.2 No. 30

Standard materials:

- Bodies – Feraloy iron alloy
- Covers – copper-free aluminum

Standard finishes:

- Feraloy – electrogalvanized and aluminum acrylic paint
- Aluminum – natural

Size ranges:

- Hub – 1/2" to 1"
- Cover opening – 3" diameter

Options:

Description

Suffix

- Bodies – copper-free aluminum **SA**
- Covers – Feraloy iron alloy..... **WOD**
Electrogalvanized and aluminum acrylic paint finish
- Corro-free epoxy powder coat..... **S752**

Ordering information:

EABC



Hub size	Cat. #
1/2"	EABC16 ^A
3/4"	EABC26 ^A
1"	EABC36 ^A

EABT



Hub size	Cat. #
1/2"	EABT16 ^A
3/4"	EABT26 ^A
1"	EABT36 ^A

EABL



Hub size	Cat. #
1/2"	EABL16 ^A
3/4"	EABL26 ^A
1"	EABL36 ^A

EABX



Hub size	Cat. #
1/2"	EABX16 ^A
3/4"	EABX26 ^A
1"	EABX36 ^A

EABY



Hub size	Cat. #
1/2"	EABY16
3/4"	EABY26

Replacement cover



Size	Cat. #
3"	EAB06

Replacement o-ring gasket

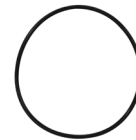

Description	Cat. #
Replacement o-ring	GASK1151

Fixture cover Union hub type



Cover opening dia.	Fixt. stem size	Cat. #
3"	3/4"	EAB0687 ^B

^A Available in copper-free aluminum. To order, add suffix 'SA' to end of catalog number.

^B EAB0687 is listed for Groups C and D only.

Condulet EAB conduit outlet boxes

Dimensions (in inches):

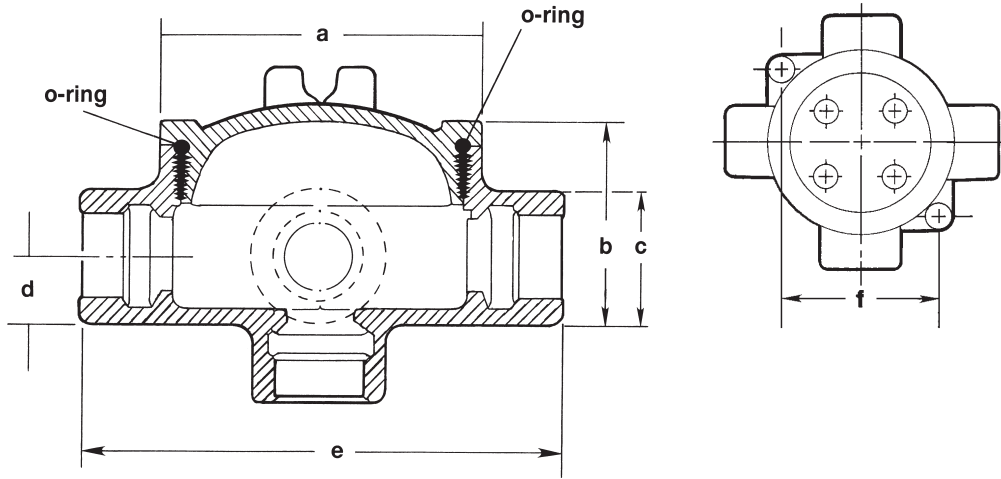

Cat. #	a	b	c	d	e	f
16	3 ³ / ₄	2 ¹⁷ / ₃₂	1 ¹ / ₂	3 ³ / ₄	5 ⁵ / ₁₆	3 ³ / ₃₂
26	3 ³ / ₄	2 ²⁵ / ₃₂	1 ³ / ₄	7 ¹ / ₈	5 ⁹ / ₁₆	3 ³ / ₃₂
36	3 ³ / ₄	2 ²⁵ / ₃₂	1 ³ / ₄	7 ¹ / ₈	5 ⁹ / ₁₆	3 ³ / ₃₂

Ordering information – factory installed terminal block ordering guide:

DIN rail mounted terminal blocks

Electrical specifications:
30A, 150V, AWG 26-10

Cat. #	Description
DIN12	DIN rail mounted, 2 terminal blocks EAB (shapes C, X, T, L) Form 6 cover diameter opening
DIN13	DIN rail mounted, 3 terminal blocks EAB (shapes C, X, T, L) Form 6 cover diameter opening
DIN14	DIN rail mounted, 4 terminal blocks EAB (shapes C, X, T, L) Form 6 cover diameter opening

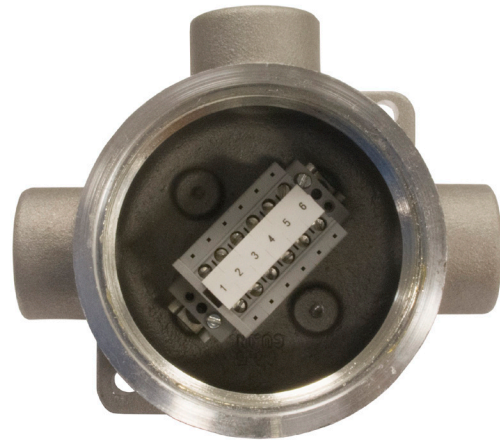

Direct mounted terminal blocks

Electrical specifications:
30A, 300V, AWG 26-10

Cat. #	Description
TB14	Direct mounted terminal block, 4 terminal blocks EAB (shapes C, X, T, L) Form 6 cover diameter opening
TB16	Direct mounted terminal block, 6 terminal blocks EAB (shapes C, X, T, L) Form 6 cover diameter opening

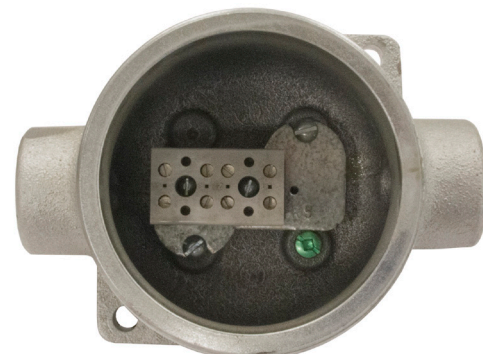

Condulet EAB ATEX conduit outlet boxes with covers

Cl. I, Div. 1 & 2, Groups A, B, C, D
 Cl. II, Div. 1 & 2, Groups E, F, G
 II 2 G EEx d IIC T5
 PTB 05 ATEX 1052
 Type 4 Enclosure; IP66

Explosionproof
 Dust-ignitionproof
 Raintight
 Wet Locations

3F

Applications:

EAB ATEX conduit outlet boxes are installed in conduit systems within hazardous areas to:

- Provide protection against exterior explosion where acetylene, hydrogen and other hazardous gases are present
- Protect conductors in threaded rigid conduit
- Act as pull and splice boxes
- Interconnect lengths of conduit
- Change conduit direction
- Provide access to conductors for maintenance and future system changes

Features:

EAB ATEX conduit outlet boxes have:

- Two different hub configurations
- Taper threaded hubs to provide ground continuity
- Smooth integral hub bushing to protect conductor insulation when pulling
- Threaded cover openings
- Surface covers furnished with boxes
- Neoprene o-ring gasket and green ground screw are both standard
- Cover threads are 16 pitch
- Internal green ground screw #10

Certifications and compliances:

NEC/CEC:

- Class I, Divisions 1 & 2, Groups A, B, C, D
- Class II, Divisions 1 & 2, Groups E, F, G
- Class III
- II 2 G EEx d IIC T5
- PTB 05 ATEX 1052
- Enclosure Type 4, IP66

UL standard:

- UL1203

CSA standard:

- cUL Listed to CSA standard: C22.2 No. 30

Standard materials:

- Bodies – Feraloy iron alloy or copper-free aluminum
- Covers – copper-free aluminum

Standard finishes:

- Feraloy – electrogalvanized and aluminum acrylic paint
- Aluminum – natural

Options:

Description

- Corro-free epoxy powder coat..... **S752**

Suffix

- Hub – ½" to 1"
- Cover opening – 3" diameter

Ordering information:

EABX



Hub size	Body material	Cat. #
½"	Feraloy iron	EABX16 ATEX
¾"	Feraloy iron	EABX26 ATEX
1"	Feraloy iron	EABX36 ATEX
1"	Copper-free aluminum	EABX36 SA ATEX

EABY



Hub size	Body material	Cat. #
½"	Feraloy iron	EABY16 ATEX
¾"	Feraloy iron	EABY26 ATEX

Size ranges:

- Hub – ½" to 1"
- Cover opening – 3" diameter

Replacement cover



Size	Cat. #
3"	EAB06

Replacement o-ring gasket

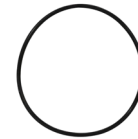

Description	Cat. #
Replacement o-ring	GASK1151

Fixture cover Union hub type



Cover opening dia.	Fixt. stem size	Cat. #
3"	¾"	EAB0687 ^A

Dimensions (in inches):

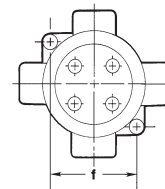
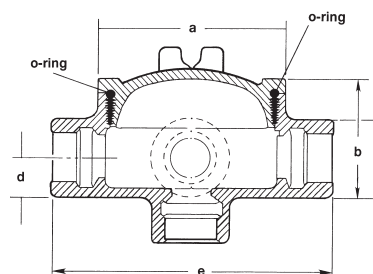

Cat. #	a	b	c	d	e	f
16	¾"	2 ¹⁷ / ₃₂ "	1½"	¾"	5 ⁵ / ₁₆ "	3 ³ / ₃₂ "
26	¾"	2 ²⁵ / ₃₂ "	1¾"	7 ⁷ / ₈ "	5 ⁹ / ₁₆ "	3 ³ / ₃₂ "
36	¾"	2 ²⁵ / ₃₂ "	1¾"	7 ⁷ / ₈ "	5 ⁹ / ₁₆ "	3 ³ / ₃₂ "

Authorised Distributor:

AMPMECH

46, Jalan SS 22/21, Damansara Jaya,
 47400 Petaling Jaya,
 Selangor Darul Ehsan, Malaysia.

Email: ampmech@ampmech.com
 Website: www.ampmech.com

^AEAB0687 is listed for Groups C and D only.