

Rosemount™ Tank Gauging Accessories



Accessories for the Rosemount Tank Gauging system, including:

- Tankbus FF terminator
- Tankbus FF coupler
- Rosemount 2180 Field Bus Modem
- Safety switch

Overview

Tankbus FF terminator

A Tankbus terminator is required at the end of the Tankbus. The external Tankbus terminator eliminates signal reflections at the end of the cable and converts the tankbus signal transmitted as a current into a voltage, which is detectable by all devices.

There is no need for a separate bus terminator if a Rosemount 2230 Graphical Field Display, Rosemount 2240S Multi-input Temperature Transmitter, or Rosemount 5900S Radar Level Gauge is the last device on the bus.

Figure 1: A Tankbus Terminator at the End of the Tankbus

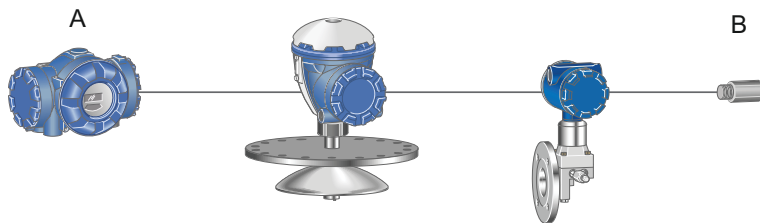

- A. Rosemount 2410 Tank Hub
- B. Tankbus FF terminator

Contents

Overview.....	2
Ordering information.....	6
Specifications for the Tankbus FF terminator.....	8
Specifications for the Tankbus FF coupler.....	10
Specifications for Rosemount 2180 Fieldbus Modem.....	14
Specifications for the safety switch.....	15
Dimensional drawings.....	17

Tankbus FF coupler

The 6-channel Tankbus segment coupler is designed for FOUNDATION™ Fieldbus systems and is Entity and FISCO compliant. It includes adjustable spur short circuit protection and an integrated switchable bus termination. The segment coupler is typically used as a junction box to distribute the Tankbus to multiple tanks and/or transmitters.

The spur circuit protection maximum current limitation is selected for all channels via a rotary switch. Different current values, 30, 35, 45 and 60 mA, can be selected, which allows all Rosemount tank gauging devices to be connected and protected.

Figure 2: Segment Couplers Distribute the Tankbus to Multiple Tanks or Transmitters

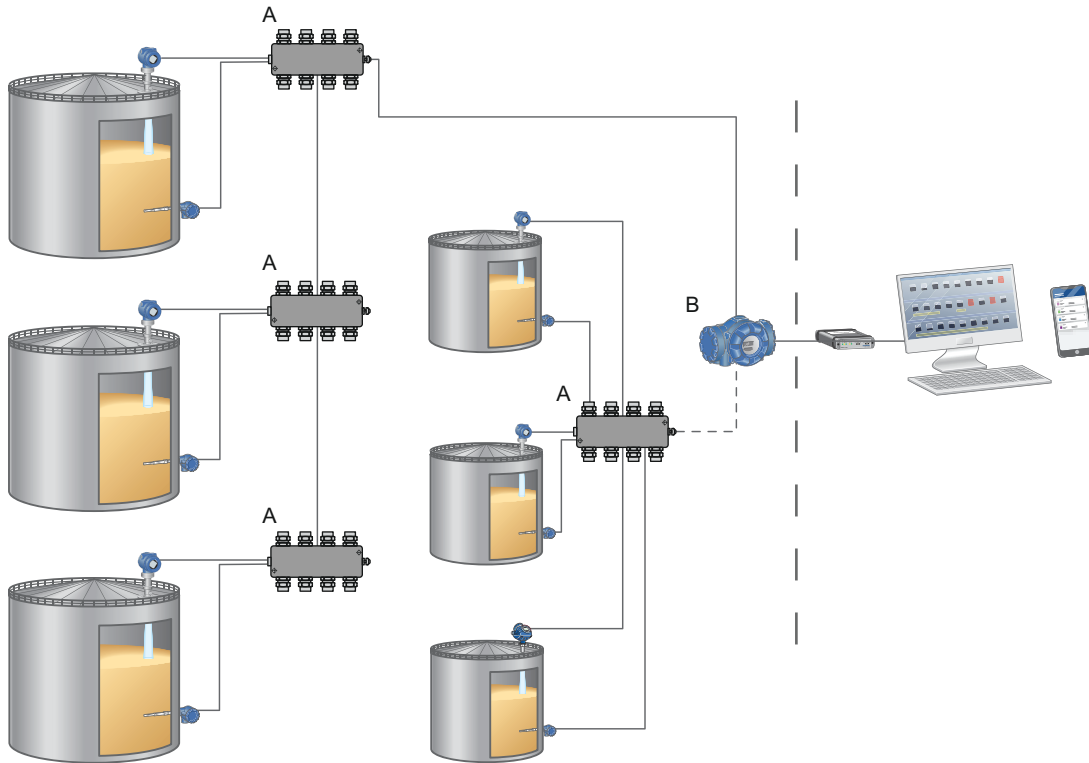

- A. Tankbus FF coupler
- B. Rosemount 2410 Tank Hub

Rosemount 2180 Field Bus Modem

The Rosemount 2180 Field Bus Modem (FBM) is used for connecting a TankMaster PC to the TRL2 communication bus. The Rosemount 2180 is connected to the PC using either the USB or the RS232 interface.

The field bus modem has LEDs to indicate power-on and communication, and if required front panel switches to set gain and termination. The modem is fitted on a standard DIN rail with the mounting kit included in all deliveries.

The Rosemount 2180 is delivered with cables for RS232 and USB connection. The USB cable also supplies power to the modem. A separately power supply cable (included in delivery) is only necessary for the RS232 option.

Figure 3: Rosemount 2180 Used for Connecting a TankMaster PC to the TRL2 Communication Bus

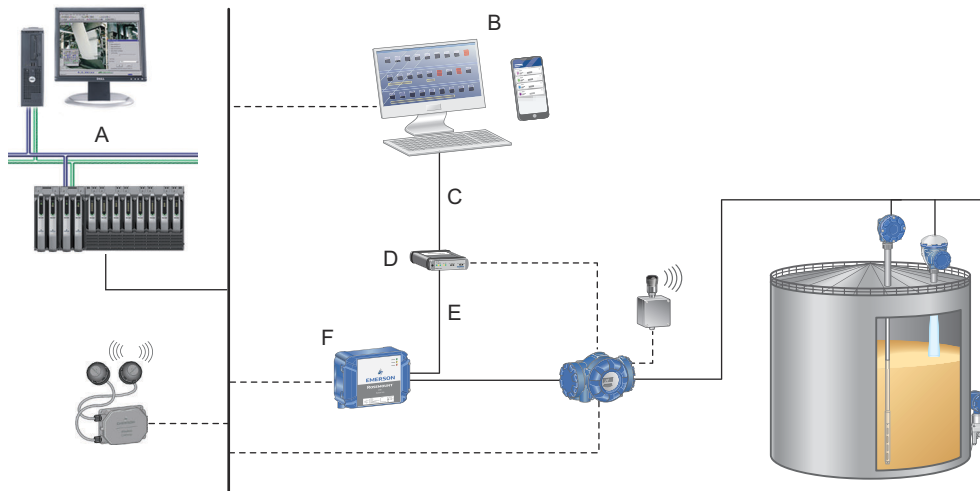

- A. DCS/Host
- B. Rosemount TankMaster™ PC
- C. USB or RS232 Modbus®
- D. Rosemount 2180 Field Bus Modem
- E. TRL2 Modbus
- F. Rosemount 2460 System Hub

Safety switch

The safety switch is an explosion proof circuit breaker between the power source and the Rosemount 2410 Tank Hub. The switch is recommended to ensure that power is disconnected during service.

Figure 4: Safety Switch connected to Rosemount 2410 Tank Hub

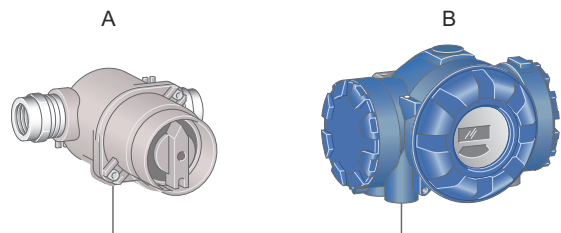

A. *Safety switch*

B. *Rosemount 2410 Tank Hub*

Ordering information

Tankbus FF terminator



- Prevents reflections/distortions
- Protection degree IP 67

Table 1: Tankbus FF Terminator Ordering Information

Item number	Product description
05900-1000-0002	Tankbus termination, external, ½-in. NPT male thread. Termination for external installation, mounted on a junction box or a transmitter field housing, IP 67. Entity and FISCO compliant.

Tankbus FF coupler

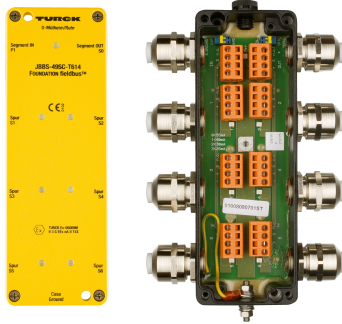

- Entity and FISCO compliant
- Adjustable spur short-circuit protection
- Robust die-cast aluminum housing
- Protection degree IP 67
- Integrated bus termination

Table 2: Tankbus FF Coupler Ordering Information

Item number	Product description
05900-1000-0001	Tankbus segment coupler with integrated user-selectable on/off termination and spur short-circuit protection (max 60 mA/spur). Connections; trunk input, trunk output, 6 spurs M20 x 1.5. Wall-mounted, IP 67. Delivered with junction box. Entity and FISCO compliant.

Rosemount 2180 Field Bus Modem



- Increases the maximum possible distance between a Rosemount 2460 System Hub and a TankMaster PC
- Features diagnostic LEDs on front cover
- Enables multidrop - one TankMaster can communicate with several Rosemount 2460 units
- Provides multiple mounting options

[VIEW PRODUCT >](#)

Table 3: Rosemount 2180 Field Bus Modem Ordering Information

Item number	Product description
FBM 2180	Fieldbus Modem

Safety switch



- Body and cover in low copper content aluminium alloy
- Frontal aluminium handle
- Cover fitted with stainless steel closing screws
- Fixing lugs
- Internal/external stainless steel earth screws
- RAL 7035 polyester coating

Table 4: Safety Switch Ordering Information

Item number	Product description
05900-1000-0003	The CSC-216 power safety switch is a 16 A rotary type switch with a front control handle. Supplied with two adapters in galvanized steel.

Specifications for the Tankbus FF terminator

Fieldbus interface

Connection

2-wire cable, red+, black-

Rated voltage

≤ 32 Vdc

Ambient conditions

Ambient temperature

-50 to + 85 °C (-58 to +185 °F)

Storage temperature

-50 to + 85 °C (-58 to +185 °F)

Mechanical specifications

Core cross-section

0.75 mm²

Protection degree

IP 67

Weight

100 g (0.2 lb)

Mounting

½ NPT thread

Directive conformity

Electromagnetic compatibility

Directive 2014/30/EU

EN 61326-1:2013

Standard conformity

Electromagnetic compatibility

NE 21:2011

Protection degree

IEC/EN 60529

Fieldbus standard

IEC 61158-2

Hazardous location certifications

EC-Type Examination Certificate

DMT 01 ATEX 104 X

Group, category, type of protection, temperature class

⊕ II 1 G EEx ia IIC T6

Directive conformity

Directive 2014/34/EU

EN 60079-0:2012 , EN 60079-1:2014 , EN 60079-11:2012 , EN 60079-18:2015

International approvals

IECEX approval

IECEX BVS 10.0022X

Approved for

Ex ia IIC T6 Ga

Hazardous location data

Temperature class

- T6 for ambient temperatures: ≤ 60 °C
- T5 for ambient temperatures: ≤ 75 °C
- T4 for ambient temperatures: ≤ 85 °C

Specifications for the Tankbus FF coupler

General specifications

Electrical specification cable glands

- TRUNK IN 1 x M20 x 1.5 (Ø 6 to 13 mm), nickel-plated brass
- TRUNK OUT 1 x M20 x 1.5 (Ø 6 to 13 mm), nickel-plated brass
- Spur 6 x M20 x 1.5 (Ø 6 to 13 mm), nickel-plated brass
- Terminal cross-section 2.5 mm²
- Earthing bolt M5 x 1

Figure 5: Segment coupler features

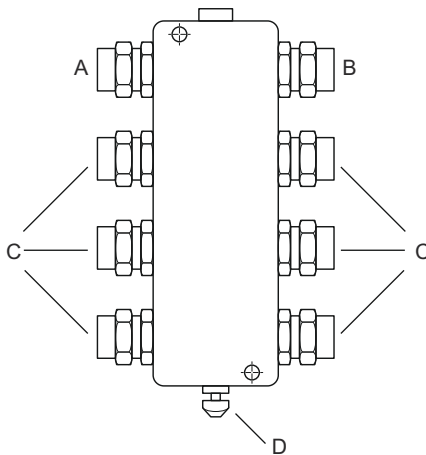

- A. Trunk IN
- B. Trunk OUT
- C. Spurs
- D. Case ground

Fieldbus standard

IEC 61158-2

Operating voltage range

- 12 to 32 Vdc
- Current self-consumption ≤ 7 mA
- Voltage drop ≤ 0.3 V

Short-circuit protection

≤ 30, ≤ 35, ≤ 45, ≤ 60 mA

Ex approval according to conformity certificate PTB 03 ATEX 2236

Entity Parameter

- Maximum output voltage $U_o \leq 24 \text{ V}$
- Maximum output current $I_o \leq 250 \text{ mA}$
- Maximum output power $P_o \leq 2560 \text{ mW}$
- Maximum input voltage $U_i \leq 24 \text{ V}$
- Maximum input current $I_i \leq 250 \text{ mA}$
- Maximum input power $P_i \leq 2560 \text{ mW}$

FISCO parameter according to IEC TS 60079-27

- Maximum output voltage $U_o \leq 17.5 \text{ V}$
- Maximum output current $I_o \leq 380 \text{ mA}$
- Maximum output power $P_o \leq 5320 \text{ mW}$
- Maximum input voltage $U_i \leq 17.5 \text{ V}$
- Maximum input current $I_i \leq 380 \text{ mA}$
- Maximum input power $P_i \leq 5320 \text{ mW}$

External inductance/capacitance Li/Ci trunk (in/out):

Negligible/ $\leq 5.00 \text{ nF}$

Per field current circuit:

Negligible/ $\leq 0.82 \text{ nF}$



Σ field current circuits:

Negligible/ $\leq 5.00 \text{ nF}$

Device designation:

-  II 2 G Ex ib IIC T4 Gb

Device marking:

-  II 2 (1) G Ex ia [ia Ga] IIC T4 Gb
-  II 2 (1D) G Ex ia [ia IIIC Da] IIB T4 Gb
-  II 2 (2D) G Ex ib [ib IIIC Db] IIB T4 Gb
- FISCO/Entity field device

Protection class

IP 67

Ambient temperature

-25 to +70 °C (-13 to +158 °F)

Housing material

Powder-coated die-cast aluminum

Housing color

Black/Yellow

Connection mode

Wall mounting with nickel plated brass cable glands

Tankbus FF Coupler Usage Example

Figure 6: Field Devices Connected via Tankbus FF Couplers

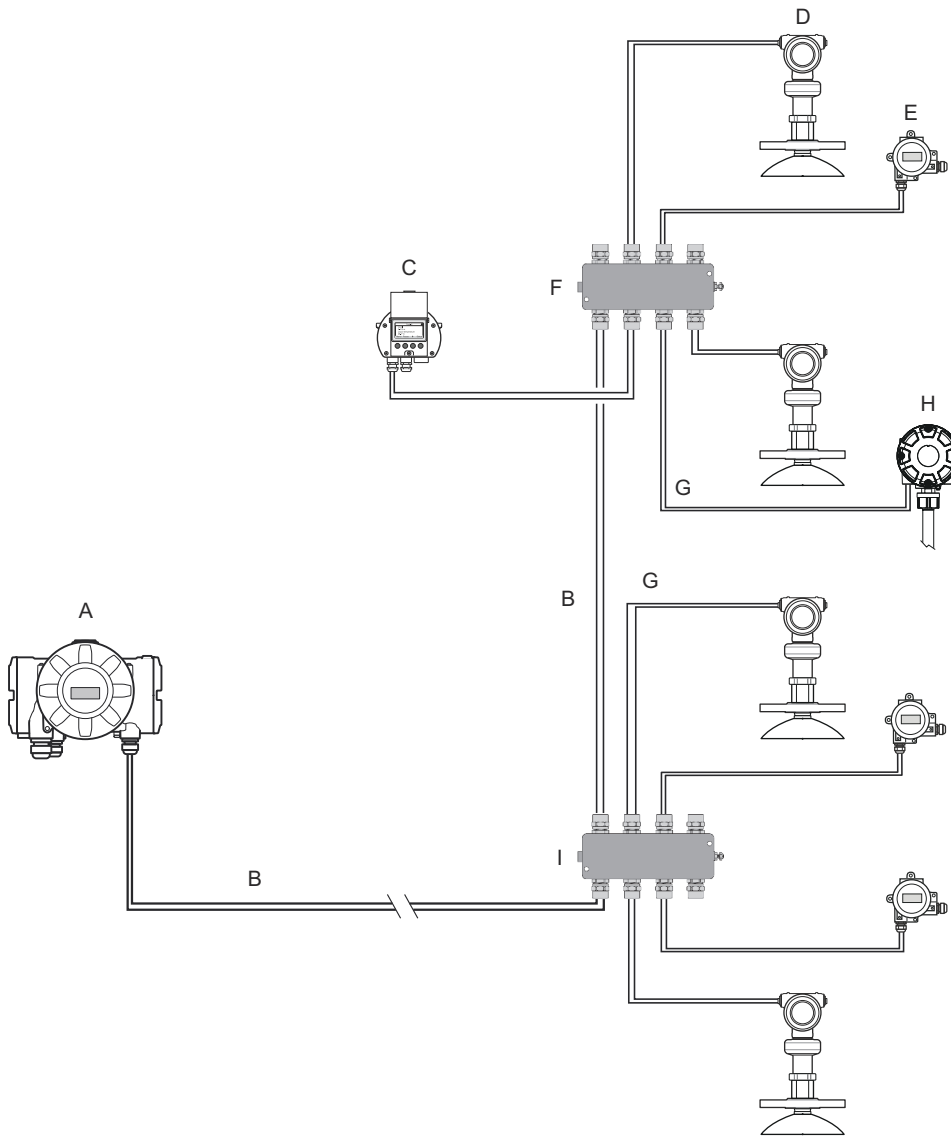

- A. Rosemount 2410 Tank Hub
- B. Tankbus (trunk)
- C. Rosemount 2230 Graphical Field Display
- D. Rosemount 5408 Level Transmitter
- E. Rosemount 644 Temperature Transmitter
- F. Tankbus FF coupler with active terminator (end of trunk)
- G. Spur < 60 m (196 ft.)
- H. Rosemount 2240S Multi-input Temperature Transmitter
- I. Tankbus FF coupler

Specifications for Rosemount 2180 Fieldbus Modem

General specifications

Protocol

Modbus®

Baudrate

4800

Explosion protection

None

Power supply (only used for RS232)

AC/DC converter supplied (7-12 V, 50 mA)

Cable to PC

- RS232: 3 m (10 ft)
- USB: 3 m (10 ft)
- Included in delivery

Fieldbus over-voltage protection

Galvanic insulation, and transient suppressors

Ambient temperature

0 to + 55 °C (32 to +130 °F)

Specifications for the safety switch

Mechanical specifications

Body and lid

Low copper content aluminium alloy, complete with wall fastening lugs

Gaskets

Acid, hydrocarbon and high temperature resistant silicon positioned between the body and the cover

Control lever

Coated aluminium alloy

Certification label

Adhesive affixed to external surface

Badge

Anodised aluminium, white lettering on black background

Internal bushing and pin

Stainless steel

Screws

Stainless steel

Earth screw

Internal M5 on body and lid connected by a 2.5 mm² wire

Coating

Polyester RAL 7035 (Light grey)

Threaded entries

One upper and one lower Ø 1-in. complete with 1-in. male and ¾-in. female adapter

Corrosion resistance

Tested according to standards:

- EN 60068-2-30 (hot/humid cycles)
- EN 60068-2-11 (salt mist tests)

Protection class

IP 66

Electrical specifications

Switches

16 A, 690 V

Hazardous locations certificates

Europe

ATEX

I M2 Ex db I Mb

II 2 GD Ex db IIC T6, T5 Gb

Ex tb IIIC T85 °C, T100 °C Db

Certificate CESI 01 ATEX 092X ENG

International

IEC Ex

II 2 GD Ex db I Mb

Ex db IIC T6, T5 Gb

Ex tb IIIC T85 °C, T100 °C Db

Certificate IECEx CES 17.0001X

Technical Regulations Customs Union (EAC)

TR CU

1Ex d IIC T6 Gb

Ex tb IIIC T85 °C Db

Certificate B.02184

Dimensional drawings

Fieldbus FF Terminator

Figure 7: Fieldbus FF Terminator dimensions

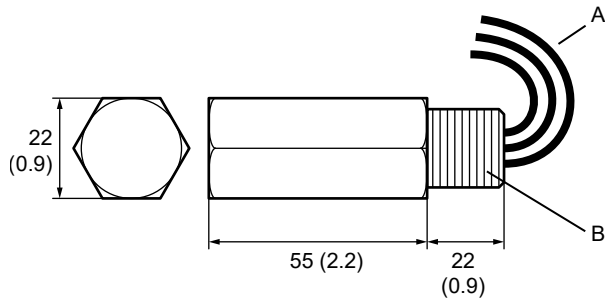

A. Cable cross sectional area 1.0 mm (0.04 in.). Cable length minimum 290 mm (11.4 in.).

B. FN: 1/2-in. NPT thread

Dimensions are in millimeters (inches).

Tankbus FF Coupler

Figure 8: Tankbus FF Coupler dimensions

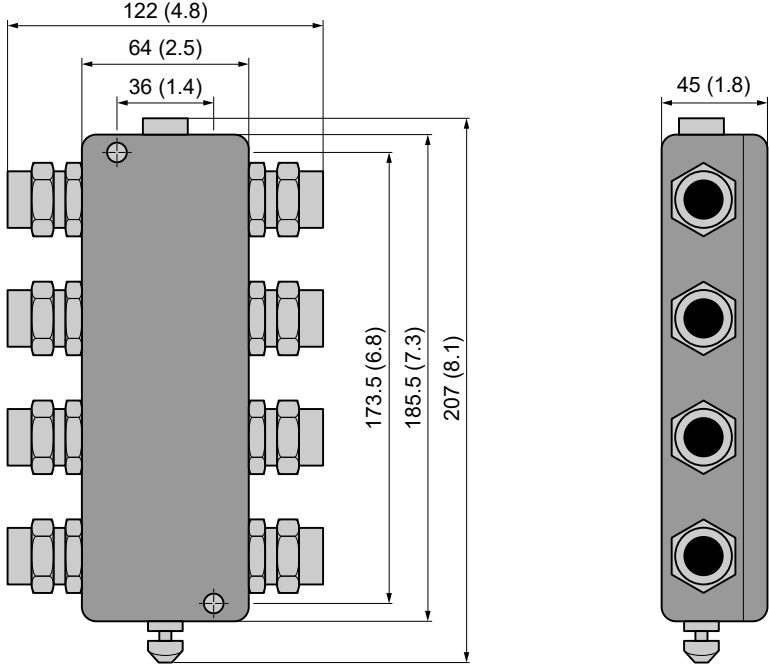

Dimensions are in millimeters (inches).

Rosemount 2180 Field Bus Modem

Figure 9: Rosemount 2180 Field Bus Modem dimensions

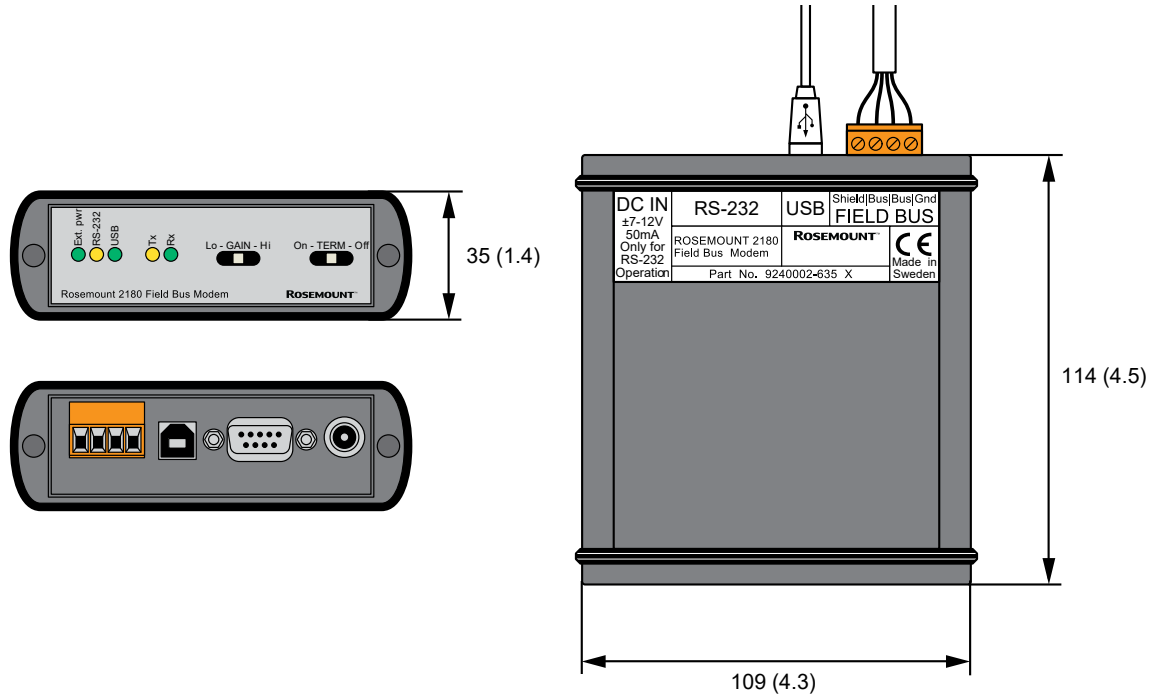

Dimensions are in millimeters (inches).

Safety switch

Figure 10: Safety Switch Dimensions

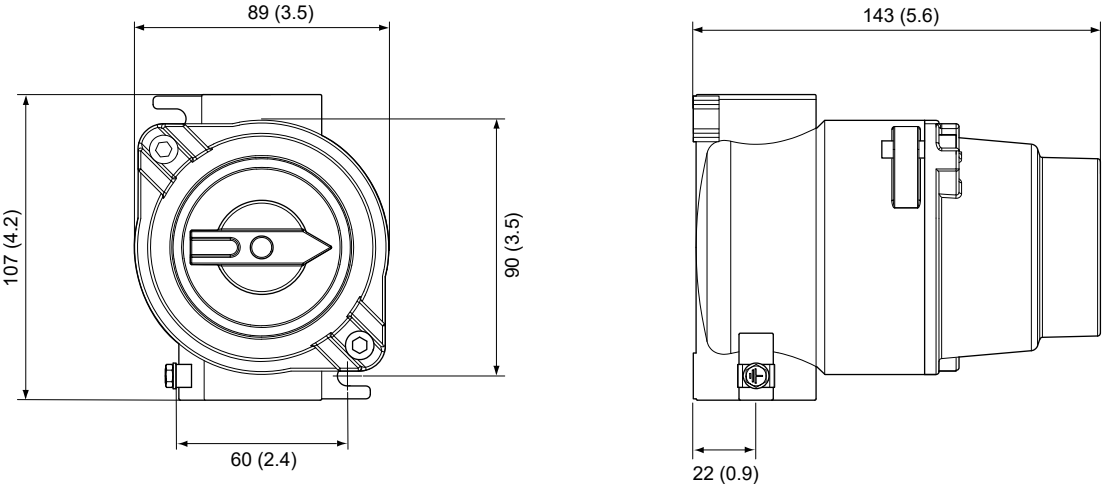

Dimensions are in millimeters (inches).

For more information: [Emerson.com/global](https://emerson.com/global)

©2024 Emerson. All rights reserved.

Emerson Terms and Conditions of Sale are available upon request. The Emerson logo is a trademark and service mark of Emerson Electric Co. Rosemount is a mark of one of the Emerson family of companies. All other marks are the property of their respective owners.

Authorised Distributor:



46, Jalan SS 22/21, Damansara Jaya,
47400 Petaling Jaya,
Selangor Darul Ehsan, Malaysia.
Email: ampmech@ampmech.com
Website: www.ampmech.com

ROSEMOUNT™

