

R72G, R72R - EXCELON® Modular System

Pressure regulators

- Port size: 1/4" or 3/8" (ISO G/PTF)
- Excelon design allows in-line or modular installation
- Balanced valve design for optimum pressure control
- Push to lock adjusting knob with tamper resistant accessory



Technical features

Medium:

Compressed air only

Maximum operating pressure:
20 bar (300 psi)

Pressure range:

Standard
0,3 ... 10 bar (4 ... 145 psi)
0,3 ... 4 bar (4 ... 58 psi) optional
0,3 ... 2 bar (4 ... 29 psi) optional

Port size:

G1/4, G3/8, 1/4 or 3/8 NPT

Gauge port:

Rc 1/8 with ISO G main ports
1/8 PTF with PTF main ports

Flow:

33 dm³/s maximum
At port size: 1/4"
Inlet pressure 10 bar (145 psi);
6,3 bar (91 psi) set pressure and a
 Δp : 1 bar (14,5 psi) droop from set.

Return valve:

R72G – without return valve
R72R – with return valve

Ambient/Media temperature:

-34 ... +65°C (-29 ... +149°F)
Air supply must be dry enough to avoid ice formation at temperatures below +2°C (+35°F).

Materials:

Body: Die cast zinc
Bottom plug: Acetal
Bonnet: Acetal
Valve: Brass
Elastomers: NBR

Technical data R72G - standard models

Symbol	Port size	Size	Pressure range (bar)	Adjustment	Weight (kg)	Model
	G1/4	Basic	0,3 ... 10	Knob	0,36	R72G-2GK-RMN
	G3/8	–	0,3 ... 10	Knob	0,36	R72G-3GK-RMN

Technical data R72R - Reverse flow

Symbol	Port size	Size	Pressure range (bar)	Adjustment	Weight (kg)	Model
	G1/4	Basic	0,3 ... 10	Knob	0,36	R72R-2GK-RMN
	G3/8	–	0,3 ... 10	Knob	0,36	R72R-3GK-RMN

Option selector

Return valve	Substitute			Gauge	Substitute
Without (standard)	G	←	R72★-★★K-★★★	With	G
Integrated	R			Without (standard)	N
Port size	Substitute	←		Outlet pressure adjustment range *2)	Substitute
1/4"	2			0,3 ... 2 bar	C
3/8"	3			0,3 ... 4 bar	F
Thread form	Substitute	←		0,3 ... 10 bar (standard)	M
PTF	A			Diaphragm	Substitute
ISO G parallel (standard)	G			Relieving (standard)	R
				Non relieving	N

*2) Outlet pressure can be adjusted to pressures in excess of, and less than, those specified. Do not use these units to control pressures outside of the specified ranges.

Flow characteristics

Inlet pressure: 10 bar (145 psi)
Port size: 1/4"

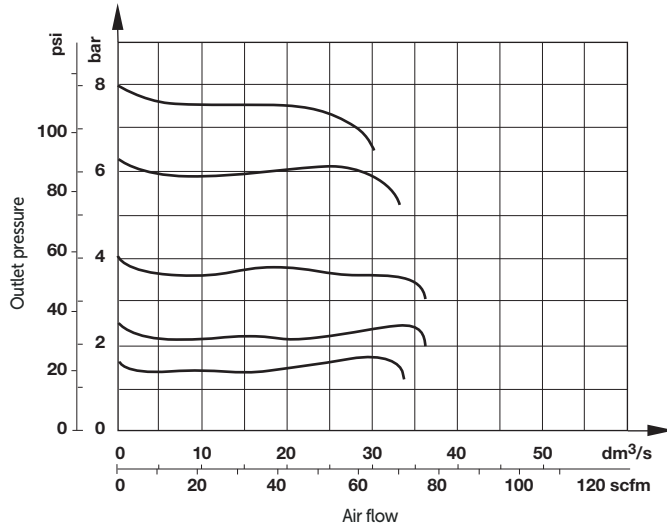

Accessories

Universal mounting bracket Page 4 4224-50	Quikclamp® Page 3 4214-51	Quikclamp with wall bracket® Page 3 4214-52	Neck mounting bracket Page 4 74316-50	Panel nut 4248-89
Tamper resistant kit 4255-51	Quikmount pipe adaptor *1) Page 3 G1/4: 4215-08 G3/8: 4215-09 1/4 PTF: 4215-02 3/8 PTF: 4215-03	Porting block with three alternative 1/4" ports Page 3 G1/4: 4216-52 1/4 PTF: 4216-50	2/2 Shut-off valves (for full technical specification see datasheet 8.160.600) Page 4 G1/4: T72B-2GA-P1N G3/8: T72B-3GA-P1N 1/4 PTF: T72B-2AA-P1N 3/8 PTF: T72B-3AA-P1N	3/2 Shut-off valves (for full technical specification see datasheet 8.160.600) Page 4 G1/4: T72T-2GA-P1N G3/8: T72T-3GA-P1N 1/4 PTF: T72T-2AA-P1N 3/8 PTF: T72T-3AA-P1N

*1) Please use a Quikmount pipe adaptor if the Quikclamp be mounted at inlet or outlet side.

Pressure switch

Porting block for pressure switch 0523109000000000	Pressure switch (0,5 ... 8 bar) 0881300000000000
--	--

Padlock

Padlock (brass) with two keys *1) 0613633000000000
--

*1) for shut-off valves and tamper resistant kit

Service kit

Service kit R72G-KITR

Gauge

Center back connection, white face (for full technical specification see datasheet 8.900.900)



Pressure range
bar *1 Mpa psi

bar *1	Mpa	psi	Ø	Thread size	Model
0 ... 2,5	—	0 ... 36	40 mm	R1/8	18-015-886
0 ... 4	0 ... 0,4	0 ... 58	40 mm	R1/8	18-015-990
0 ... 10	0 ... 1	0 ... 145	40 mm	R1/8	18-015-989

*1) primary scale

Center back connection, black face for North America (for full technical specification see datasheet 8.900.900)
Pressure range



psig *1 bar Mpa

psig *1	bar	Mpa	Ø	Thread size	Model
0 ... 30	0 ... 2	0 ... 0,2	1.5" (40 mm)	1/8 NPT	18-015-214
0 ... 60	0 ... 4	0 ... 0,4	1.5" (40 mm)	1/8 NPT	18-015-211
0 ... 160	0 ... 11	0 ... 1,1	1.5" (40 mm)	1/8 NPT	18-015-212

*1) primary scale

Drawings

Dimensions in mm
Projection/First angle

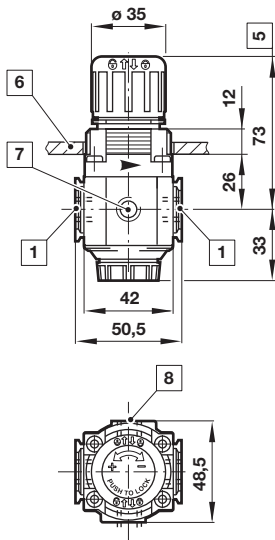

- 1 Main ports 1/4" or 3/8"
- 5 Reduces by 4 mm with knob in locked position
- 6 Panel thickness 0 ... 4 mm
- 7 Gauge port 1/8" plugged
- 8 Alternative gauge port 1/8" plugged

Accessories

Quikclamp®

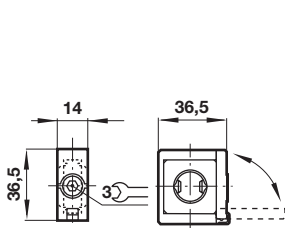

Quikclamp® with wall bracket

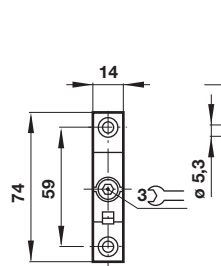

Porting block

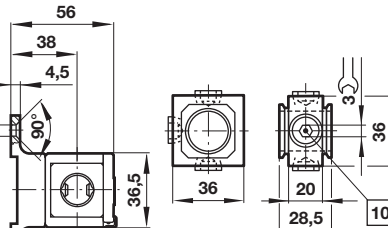

- 10 Ports (G1/4 or 1/4 NPT) plugged

Pipe adapter

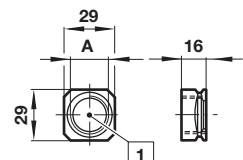

- 1 Main ports 1/4" or 3/8" (ISO G/PTF)

Wall mounting bracket

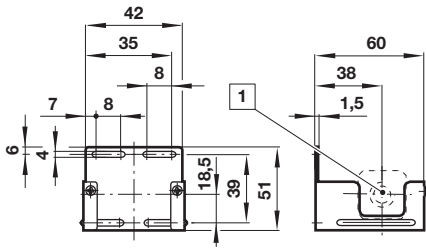

1 Main ports

Neck mounting bracket

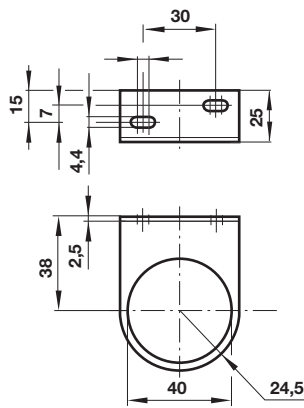

Shut-off valves

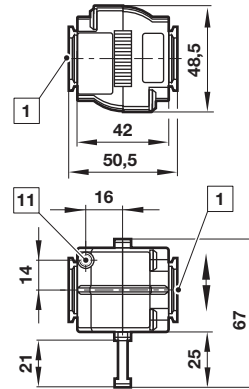

1 Main ports 1/4" or 3/8" ISO G/PTF
11 Exhaust port M5 at 3/2 valve only

Dimensions in mm
Projection/First angle



Porting block for pressure switch

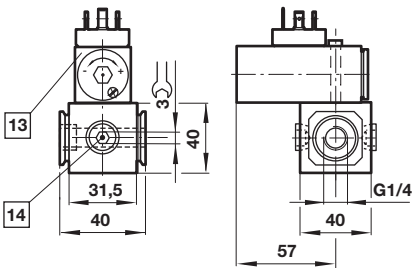

13 Pressure switch is not in scope of delivery
14 Alternative G1/4 ports plugged

Authorised Distributor:



46, Jalan SS 22/21, Damansara Jaya,
47400 Petaling Jaya,
Selangor Darul Ehsan, Malaysia.
Email: ampmech@ampmech.com
Website: www.ampmech.com

Warning

These products are intended for use in industrial compressed air systems only. Do not use these products where pressures and temperatures can exceed those listed under »**Technical features/data**«.

Before using these products with fluids other than those specified, for non-industrial applications, life-support systems or other applications not within published specifications, consult IMI Precision Engineering, Norgren Inc.

Through misuse, age, or malfunction, components used in fluid power systems can fail in various modes. The system designer is warned to consider the failure modes of all component parts used in fluid power systems and to provide adequate safeguards to prevent personal injury or damage to equipment in the event of such failure.

System designers must provide a warning to end users in the system instructional manual if protection against a failure mode cannot be adequately provided.

System designers and end users are cautioned to review specific warnings found in instruction sheets packed and shipped with these products.